

OPERATING, MAINTENANCE & PARTS MANUAL

MANUAL DE FUNCIONAMIENTO,
MANTENIMIENTO Y PIEZAS

MANUEL D'ENTRETIEN,
D'OPÉRATION ET DE PIÈCES

LHH SERIES

LHH SERIES

LHH SERIES

COFFING® HOISTS

Before using hoist, fill in the information below:

Antes de instalar el polipasto, rellene los datos siguientes.
Enregistrez les informations suivantes avant de faire l'installation.

Model No. / Carga Nominal / Charge nominale _____

Serial No. / N° de Serie / No. de Ser. _____

Purchase Date / Fecha de Compra / Date d'achat _____

CAPACITIES: 1000 – 10,000 LBS

Follow all instructions and warnings for inspecting, maintaining and operating this hoist.

The use of any hoist presents some risk of personal injury or property damage. That risk is greatly increased if proper instructions and warnings are not followed. Before using this hoist, each operator should become thoroughly familiar with all warnings, instructions, and recommendations in this manual. **Retain this manual for future reference and use.**

Forward this manual to operator.

Failure to operate equipment as directed in manual may cause injury.

Should you have any questions or have problems with this product, please call Coffing Hoists at (800) 477-5003.

CAPACIDADES DE CARGA: 1000 – 10,000 LBS

Siga todas las instrucciones y advertencias para inspeccionar, mantener y operar este polipasto.

El uso de cualquier polipasto presenta algunos riesgos de daños a las personas o a las cosas. Este riesgo se ve incrementado si no se siguen correctamente las instrucciones y advertencias. Antes de usar el polipasto el operario debería estar familiarizado con todas las advertencias, instrucciones y recomendaciones de este manual. **Guarda este manual para futuras consultas.**

Entregue este manual al operario. Si el equipo no se maneja tal y como se recomienda en el presente manual, es posible que se produzcan situaciones de peligro que pueden resultar en daños personales.

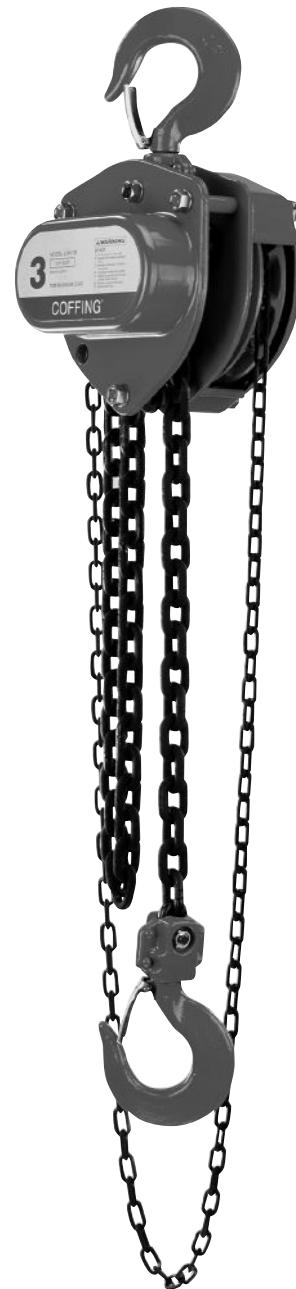

CHARGES NOMINALES: 1000 – 10,000 LBS

Veillez vous conformer à toutes les instructions et avertissements d'inspection, d'entretien et d'opération de ce palan.

L'utilisation de tout appareil de levage comporte des risques de blessures ou de dégâts matériels. Ces risques sont de beaucoup accrus si les instructions et avertissements ne sont pas suivis. Tous les opérateurs devraient se familiariser complètement avec toutes les recommandations instructions et avertissements de ce manuel avant d'utiliser ce palan. **Conservez ce manuel pour utilisation et référence future.**

Remettez ce manuel à l'opérateur. L'utilisation de cet équipement contrairement aux directives de ce manuel peut causer des blessures.

COFFING HOIST PARTS AND SERVICES ARE AVAILABLE IN THE UNITED STATES AND IN CANADA

As a COFFING Hoist and Trolley user you are assured of reliable repair and parts services through a network of Master Parts Depots and Service Centers that are strategically located in the United States and Canada. These facilities have been selected on the basis of their demonstrated ability to handle all parts and repair requirements promptly and efficiently. To quickly obtain the name of the Master Parts Depot or Service Center located nearest you, call (800) 888-0985. Fax: (716) 689-5644.

LAS PIEZAS Y REPARACIONES DE LOS POLIPASTOS DE COFFING ESTÁN ASEGURADAS EN ESTADOS UNIDOS Y CANADÁ

Como usuario de un polipasto y carro de COFFING le aseguramos cualquier reparación o la disponibilidad de cualquier pieza de repuesto a través de una red de almacenes de piezas de repuesto y centros de servicio situados estratégicamente en Estados Unidos y Canadá. Estas instalaciones se han seleccionado en base a su capacidad demostrada en la reparación de equipos y suministro de piezas de repuesto de forma rápida y eficaz. Para obtener la dirección del almacén de piezas de repuesto o del centro de servicio más cercano, llame al teléfono (800) 888-0985. Fax: (716) 689-5644 (sólo en Estados Unidos y Canadá).

LE SERVICE DE RÉPARATION ET DE PIÈCES POUR PALANS COFFING EST DISPONIBLE AUX ÉTATS-UNIS ET AU CANADA

Soyez assurés qu'en temps d'utilisateur de palan et treuil COFFING, d'un service de réparation et de pièces fiable par l'entremise d'un réseau de Centres de service et de Dépôts de pièces maîtresses qui sont stratégiquement situés aux États-Unis et au Canada. Ces établissements ont été sélectionnés sur une base de leur habileté démontrée à s'occuper promptement et efficacement des besoins de réparation de pièces. Appelez le (800) 888-0985, Fax: (716) 689-5644 pour obtenir rapidement le nom du dépôt de pièces maîtresses ou du centre de service situé le plus près.

HOIST SAFETY IS UP TO YOU...

⚠ WARNING

- DO NOT LIFT MORE THAN RATED LOAD.
- DO OPERATE WITH MANUAL POWER ONLY (ONE OPERATOR)

CHOOSE THE RIGHT HOIST FOR THE JOB...

Choose a hoist with the capacity for the job. Know the capacities of your hoists and the weight of your loads.

Then match them.

The application, the size and type of load, the attachments to be used and the period of use must also be taken into consideration in selecting the right hoist for the job.

Remember, the hoist was designed to ease our burden and carelessness not only endangers the operator, but in many cases, a valuable load.

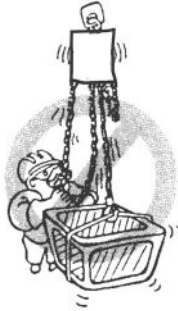

⚠ WARNING

- DO NOT OPERATE DAMAGED OR MALFUNCTIONING HOIST.
- DO NOT OPERATE WITH TWISTED, KINKED, OR DAMAGED CHAIN.

INSPECT

All hoists should be visually inspected before use, in addition to regular, periodic maintenance inspections.

Inspect hoists for operations warning notices and legibility.

Deficiencies should be noted and brought to the attention of supervisors. Be sure defective hoists are tagged and taken out of service until repairs are made.

Under no circumstances should you operate a malfunctioning hoist.

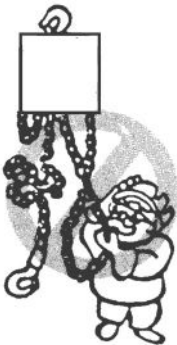

Check for gouged, twisted, distorted links and foreign material. Do not operate hoists with twisted, kinked, or damaged chain links.

Load chain should be properly lubricated.

Hooks that are bent, worn, or whose openings are enlarged beyond normal throat opening should not be used. If latch does not engage throat opening of hook, hoist should be taken out of service.

Chains should be checked for deposits of foreign material which may be carried into the hoist mechanism.

Check brake for evidence of slippage under load.

⚠ WARNING

- DO NOT PULL AT AN ANGLE. BE SURE HOIST AND LOAD ARE IN A STRAIGHT LINE.
- DO NOT USE LOAD CHAIN AS A SLING.

USE HOIST PROPERLY

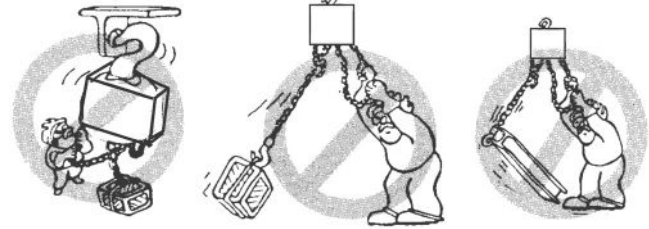

Be sure hoist is solidly held in the uppermost part of the support hook arc.

Be sure hoist and load are in a straight line. Do not pull at an angle.

Be sure load is hooked securely. Do not tip load the hook. Do not load hook latch. Hook latch is to prevent detachment of load under slack chain conditions only.

Do not operate with hoist head resting against any object. Lift the load gently. Do not jerk it.



⚠ WARNING

- DO NOT LIFT PEOPLE OR LOADS OVER PEOPLE

PRACTICE CAUTION ALWAYS

Do not lift co-workers with a hoist.

Make sure everyone is clear of the load when you lift.

Do not remove or obscure operational warning notices.

OPERATOR SERVICE

CLEANING

Hoists should be kept clean and free of dust, dirt, moisture, etc., which will in any way affect the operation or safety of the equipment.

LUBRICATION

Chain should be properly lubricated.

AFTER REPAIRS

Carefully operate the hoist before returning it to full service.

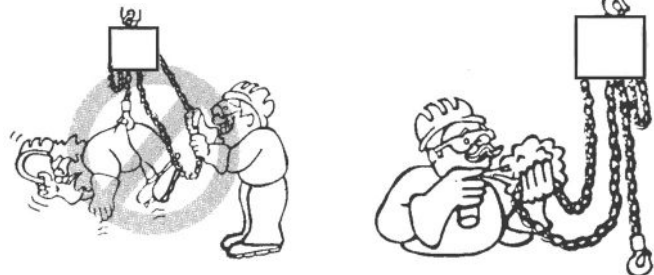

VIOLATIONS OF ANY OF THE WARNINGS LISTED MAY RESULT IN SERIOUS PERSONAL INJURY TO THE OPERATOR OR NEARBY PERSONNEL BY NATURE OF RELEASED LOAD OR BROKEN HOIST COMPONENTS.

WARNING

Improper operation of a hoist can create a potentially hazardous situation which, if not avoided, could result in death or serious injury. To avoid such a potentially hazardous situation, the operator shall:

1. **NOT** operate a malfunctioning or unusually performing hoist.
2. **NOT** operate the hoist until you have thoroughly read and understood the manufacturer's Operating and Maintenance Instructions or Manuals.
3. **NOT** operate a hoist which has been modified without the manufacturer's approval or certification to be in conformity with applicable OSHA regulations.
4. **NOT** lift or pull more than rated load for the hoist.
5. **NOT** use damaged hoist or hoist that is NOT working properly.
6. **NOT** use hoist with twisted, kinked, damaged, or worn load chain.
7. **NOT** use the hoist to lift, support, or transport people.
8. **NOT** lift loads over people and make sure all personnel remain clear of the supported load.
9. **NOT** attempt to lengthen the load chain or repair damaged load chain.
10. Protect the hoist's load chain from weld splatter or other damaging contaminants.
11. **NOT** use load chain as a sling or wrap load chain around load.
12. **NOT** apply the load to the tip of the hook or to the hook latch.
13. **NOT** apply load unless load chain is properly seated in the chain wheel(s) or sprocket(s).
14. **NOT** apply load if bearing prevents equal loading on all load supporting chains.
15. **NOT** operate beyond the limits of the load chain travel.
16. **NOT** leave load supported by the hoist unattended unless specific precautions have been taken.
17. **NOT** allow the chain or hook to be used as an electrical or welding ground.
18. **NOT** allow the chain or hook to be touched by a live welding electrode.
19. **NOT** remove or obscure the warnings on the hoist.
20. **NOT** operate a hoist which has NOT been securely attached to a suitable support.
21. **NOT** operate a hoist unless load slings or other approved single attachments are properly sized and seated in the hook saddle.
22. **NOT** operate a hoist when it is restricted from forming a straight line from hook to hook in the direction of loading.
23. **NOT** lift loads that are NOT balanced and that the holding action is NOT secure, taking up slack carefully.
24. **NOT** operate a hoist unless all persons are and remain clear of the supported load.
25. Report malfunctions or unusual performances of a hoist, after it has been shut down until repaired.
26. **NOT** operate a hoist on which the safety placards or decals are missing or illegible.
27. Be familiar with operating controls, procedures, and warnings.

CAUTION

Improper operation of a hoist can create a potentially hazardous situation which, if not avoided, could result in minor or moderate injury. To avoid such a potentially hazardous situation, the operator shall:

1. Maintain firm footing or be otherwise secured when operating the hoist.
2. Check brake function by tensioning the hoist prior to each lift or pulling operation.
3. Use hook latches. Latches are to retain slings, chains, etc. under slack conditions only.
4. Make sure the hook latches are closed and not supporting any parts of the load.
5. Make sure the load is free to move and will clear all obstructions.
6. Avoid swinging the load or hook.
7. Inspect the hoist regularly, replace damaged or worn parts, and keep appropriate records of maintenance.
8. Use the hoist manufacturer's recommended parts when repairing the unit.
9. Lubricate load chain per hoist manufacturer's recommendations.
10. **NOT** use the hoist load limiting or warning device to measure load.
11. **NOT** operate except with manual power.
12. **NOT** permit more than one operator to pull on a single hand chain at the same time. More than one operator is likely to cause hoist overload.
13. **NOT** allow your attention to be diverted from operating the hoist.
14. **NOT** allow the hoist to be subjected to sharp contact with other hoists, structures, or objects through misuse.
15. **NOT** adjust or repair the hoist unless qualified to perform such adjustments or repairs.

GENERAL SAFETY INFORMATION

ADVERSE ENVIRONMENTAL CONDITIONS

Do not use the hoists in areas containing flammable vapors, liquids, gasses or any combustible dust or fibers. Do not use the hoist in highly corrosive, abrasive, wet environments or in applications involving exposure to temperatures below -10°F or above 130°F.

MOVING HAZARDOUS LOADS

The hoists are not recommended for lifting materials that could cause widespread damage if dropped. The lifting or moving of materials that could explode or cause chemical or radioactive contamination requires fail-safe, redundant supporting devices that are not incorporated into these hoists.

TABLE OF CONTENTS

Safety Precautions 2
General Information..... 3
Installation 3
Lubrication..... 5
Inspection..... 5
Recommended Lubrication Schedule..... 5
Replacement Parts List 9
Parts Depot & Warranty Repair Centers..... 8
Warranty Back Cover

SAFETY PRECAUTIONS

Each Coffing LHH Series Manually Operated Chain Hoist is built in accordance with the specifications contained herein and at the time of manufacture complies with our interpretation of applicable sections of *American Society of Mechanical Engineers Code (ASME) B30.16 and the *American National Standards Institute ANSI/ASME HST-2M.

*Copies of this standard can be obtained from ASME Order Department, 22 Law Drive, Box 2300, Fairfield, NJ 07007-2300, U.S.A.

ENGLISH

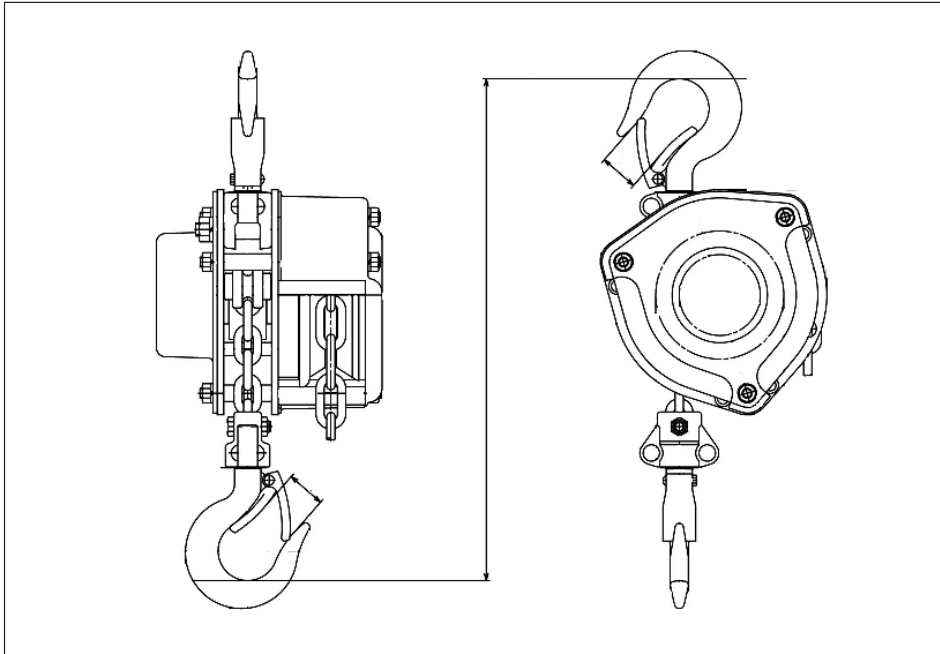

TABLE 1. GENERAL SPECIFICATIONS

Model	LHH-1/2B	LHH-1B	LHH-1½B	LHH-2B	LHH-3B	LHH-5B
Rated Load	1102 lbs 0,5 tonnes 0.55 tons	2205 lbs 1 tonnes 1.1 tons	3528 lbs 1,6 tonnes 1.7 tons	4410 lbs 2 tonnes 2.2 tons	7056 lbs 3,2 tonnes 3.5 tons	11025 lbs 5 tonnes 5.5 tons
Weight (lbs)	20	23	33	44	65	74
Standard Lift (ft)	10-15-20	10-15-20	10-15-20	10-15-20	10-15-20	10-15-20
Pull on Hand Chain to Raise Load (lbs)	55	60	66	88	84	79
Hand Chain Overhaul for 1 Foot Lift (ft)	32	56	68	75	95	203
Throat Opening of Hooks (in)	15/16	11/8	13/8	13/8	19/16	17/8
Minimum Distance Between Hooks (in)	101/4	1113/16	139/16	15	171/8	225/8
Load Chain Size Wire Diameter (mm)	5	6.3	7.1	8	10	7.1

GENERAL INFORMATION

This manual provides information for the safe operation and maintenance of Coffing Hand Chain Hoists. All persons operating or maintaining the hoist should be familiar with the information contained herein. Adherence to the precautions, procedures, and maintenance practices described should ensure long, reliable operation.

All persons responsible for the installation, operation, or maintenance of hoisting equipment should read American National Standard ANSI B30.16 for guidelines toward the safe operation of hoists. This standard contains rules pertaining to inspection requirements and records that may be required by some regulatory agencies.

HOIST CONSTRUCTION

This hand chain hoist provides an efficient means for lifting of freely suspended material loads within its load rating. The frame and covers of the hoist are of stamped steel construction.

The cast hand chain wheel and load activated brake provide smooth, precise spotting of loads.

When unpacking the hoist, inspect carefully for any damage that may have occurred during shipping. Check for loose, missing, or damaged parts.

INSTALLATION

Be sure that the structures supporting the hoist are strong enough to support the full rated load of the hoist with a generous factor of safety. The hoist should be suspended directly over the load, so that the load can be lifted without side pull. The hoist body must be free to align itself between the two hooks. Do not restrain the hoist frame in any way, or allow it to rest directly against any part of the supporting structure.

TESTING

Apply a light load to the hoist and check for smooth operation and proper brake function. If the hoist works properly with a light load, connect the rated load to the hoist and raise the load just clear of the floor. Check that the brake holds the load before lifting any higher. No drifting of the hook should occur under any size load within the hoist's load rating.

SAFETY RULES

Inspect the hoist for any sign of loose, broken or malfunctioning parts. Any malfunctioning hoist should be tagged as “out of order” and removed from service until the defect is corrected.

- a. Do not overload the hoist.
 - b. Do not exert more than the hand chain pull to lift rated load by one operator (See Table 1). The hoist is designed to lift its rated capacity when a reasonable force is exerted. If effort appears to be excessive, recheck the load and use a larger capacity hoist if necessary.
 - c. Do not side load the hoist. Always pull in a straight line between hooks. Side loading over a sharp corner may fracture the hoist housing, load block or hook.
 - d. Be sure there are no twists in the load chain and make sure that load chain is free to move and will clear all obstructions. On a multiple chained hoist it is possible for the load block to be capsized or turned over one or more times causing the chain to twist.
 - e. Do not operate the hoist from an off balance position. Operator should have firm footing or be otherwise secured before operating the hoist.
 - f. Before raising or pulling a load, always check to see that it is held securely in the hook or sling chains, etc. Raise the load only until the load chain is taut and then recheck the rigging before continuing to raise the load.
 - g. Make sure that the slings and other rigging have sufficient capacity to support the load, and are in good condition.
 - h. **DO NOT STAND BENEATH A LOAD!** Do not move a load in such a manner as to endanger personnel.
 - i. Do not leave the hoist under load for extended or unattended periods unless specific precautions have been taken to provide protection.
 - j. Do not wrap the load chain around a load. **USE A SLING!**
 - k. Do not **TIP-LOAD** any hook, as this will exert undue strain in the hook, resulting in hook failure.
 - l. The hoist is designed for manual operation by one person. Do not attempt to operate hoist with other than the manual power furnished by one person.
 - m. **DO NOT USE HOIST TO LIFT, SUPPORT OR OTHERWISE TRANSPORT HUMAN CARGO.**
 - n. The hand chain is equipped with a safety link. When the safety link opens or deforms, stop at once and inspect for the cause.
- o. Lifting a load with two hoists is not recommended. If operation is unavoidable, hoist the load with utmost care, keeping balance of the load.
 - p. Never run the load chain out too far. When operating beyond the range of lift, an excessive load that can cause damage will be imposed on the hoist.
 - q. Hoists are designed for lifting loads vertically and should not be used for horizontal or angle hoisting.
 - r. Extreme temperatures will lower the toughness of the hoist. Loads should be hoisted or lowered very slowly and carefully.
 - s. The hoisting operation should never be done with the bottom hook or load caught on a fixed object.
 - t. Never use the chain or hook as a ground for welding.
 - u. Use only genuine parts and chains supplied by the authorized distributor.

HANDLING THE LOAD

ATTACHING THE LOAD

- a. The load should be attached to the hook by means of slings or other appropriate devices. Never wrap the load chain around a load.
- b. Be sure the load is supported in the saddle of the hook and the latch is closed. Do not support a load on the tip of the hook.

LIFTING THE LOAD

- a. Raise the load by pulling the right side hand chain. Lift the load just clear of the floor. Check that slings are secure in the hook, the load is well balanced, and the hoist brake is holding the load. Lift the load to desired height, always standing clear of the suspended load.
- b. Lower the load by pulling the left side hand chain. Pull smoothly and slowly. Avoid “spinning” the hand chain.
- c. Never jam the hook block into the bottom of the hoist, or run the hook down until the slack chain is pulled tight.

PREVENTIVE MAINTENANCE

Periodic inspection and lubrication is important to ensure long and satisfactory operation of the hoist. The recommended inspection intervals indicated in Table 2 are based on intermittent operation. The user should reduce or extend his inspection intervals based on usage and individual experience.

	Diameter of Link (mm)	Standard Dimension P (inch)	Permissible Limit P (inch)
1/2 Ton Load Chain	5	.590	.602
1 Ton Load Chain	6.3	.752	.767
1½ Ton Load Chain	7.1	.835	.850
2 Ton Load Chain	7.9	.953	.972
3 Ton Load Chain	10	1.193	1.216
5 Ton Load Chain	7.1	.835	.850
Hand Chain	5	.945	.984

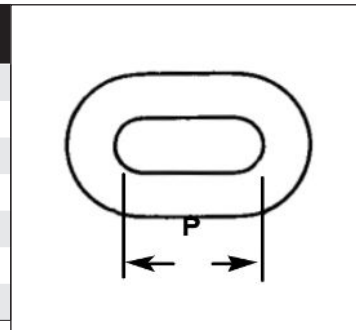

Figure 1 - Chain Wear Measurement

Use calipers to check the chain for wear as shown in Figure 1. Replace any chain showing damage or wear beyond the wear limit shown. (Make certain the caliper anvils are small enough to seat in the links.)

⚠ WARNING
If chain is worn or otherwise damaged, replace entire chain with new chain supplied by the hoist manufacturer. Do not substitute. Do not attempt to reweld damage.

HOOK DIMENSIONS (OPENING)

Inspect the hooks for deformations, chemical damage or cracks. Hooks damaged from chemicals, deformation or cracks, or hooks having throat openings greater than the “reject opening” shown in the table must be replaced. If the hook is twisted more than 10 degrees from the plane of the unbent hook, it must be replaced.

Capacity (ton)	Standard Dimension F (inch)	Reject Opening F (inch)
1/2	1.181	1.300 & Over
1	1.417	1.575 & Over
1½	1.535	1.693 & Over
2	1.653	1.811 & Over
3	1.890	2.086 & Over
5	2.205	2.440 & Over

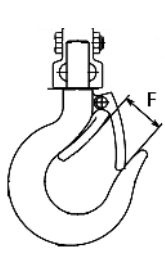

DISASSEMBLY

Disassembly of the hoist is straightforward. Note the location and orientation of the various parts.

LUBRICATION

1. Good lubrication is vital to long chain life. The load chain should be kept well oiled with SAE 30 weight oil. Be sure that the oil is worked into the area between the links.
2. If the hoist is disassembled for inspection or repair, relubricate the moving parts according to Table 3.

⚠ CAUTION
The brake surfaces must be kept free of any trace of oil or grease. Apply lubricant sparingly to the parts near the brake to avoid oil contamination of the brake

TABLE 3 - RECOMMENDED LUBRICANTS

Part	Lubricant
Gears, bearings, pawl pivot pin, guide roller pin, hook shanks, and chain wheel threads	Any good quality NLGI #2 grease
Chain	SAE 30 weight oil
Brake parts, ratchet teeth	Do Not Lubricate

ASSEMBLY

Assembly is the reverse of disassembly. Be sure to note the following points.

1. The twin gears each have an “O” stamped on them which is used as a timing mark. The twin gears must be installed so that the timing marks both point to exactly the 9 o’clock position at the same time (See Figure 2).

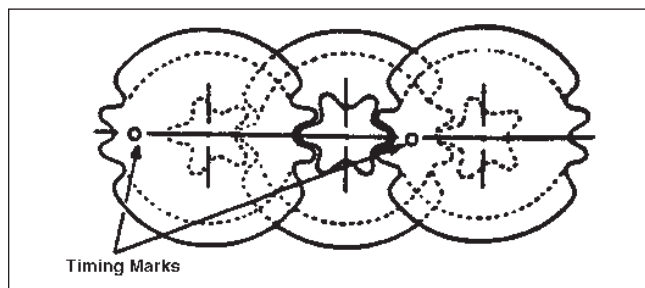

Figure 2 - Twin Gear Timing Marks

2. Assemble the brake parts as shown in the exploded view (Figure 3). Screw hand chain wheel down tight. Screw the nut down finger tight on the input shaft, then back it off approximately one-quarter turn and install the cotter pin.
3. Install chain by running a piece of wire or string between the chain guide roller and load sprocket and then over and around the load sprocket. Tie the chain to the wire or string and pull it into the hoist so that the first link is standing on edge in one of the slots of the load sprocket, with the weld away from the sprocket. Operate hoist in the UP direction, pulling about a foot of chain around the sprocket and out the hoist. Remove the cotter pin from the slack end pin and slide the pin to one side. Pull the end of the chain under the chain guide roller and hook the last link over the slack end pin, being sure the chain has no twist. Slide the slack end pin back into position and install the cotter pin through it.

⚠ CAUTION
Be sure the slack end of chain passes between the chain guide roller and the load sprocket and under the chain guide roller.

TABLE 2 - INSPECTION SCHEDULE

Interval	Inspection
Daily	<ol style="list-style-type: none"> a. Check hooks and hook latches for deformation or cracks. Twisted hooks or hooks with throat openings more than the reject openings listed in above table should be replaced. b. Visually check chain for wear and twist. c. Check brake for drift.
Quarterly	<ol style="list-style-type: none"> a. Check for loose screws, nuts, etc. b. Check load sprocket and hand chain wheel for wear.
Annually (See Disassembly)	<ol style="list-style-type: none"> a. Inspect for worn gears, bearings, pawl, pawl spring, ratchet, and shafts. b. Check for worn brake discs. c. Inspect hooks for cracks using magnetic particle or similar test. d. Clean chain in kerosene or other non-corrosive solvent and inspect for wear, nicks, or distortion of any kind.

REPAIR PARTS LIST



WARNING

Using “Commercial” or other manufacturer’s parts to repair the COFFING LHH may cause load loss.

TO AVOID INJURY:

Use only COFFING supplied replacement parts. Parts may look alike but COFFING parts are made of specific materials or processed to achieve specific properties.

ENGLISH

ORDERING INSTRUCTIONS

The following information must accompany all correspondence orders for replacement parts:

1. Hoist Model Number from identification plate.
2. Serial number of the hoist stamped below identification plate.
3. Length of lift.
4. Part number of part from parts list.
5. Number of parts required.
6. Part name from parts list.

NOTE: When ordering replacement parts, it is recommended that consideration be given to the need for also ordering such items as gaskets, fasteners, insulators, etc. These items may be damaged or lost during disassembly or just unfit for future use because of deterioration from age or service.

RECOMMENDED SPARE PARTS

Certain parts of your hoist will, in time, require replacement under normal wear conditions. It is suggested that the following parts be purchased for your hoist as spares for future use.

- Pawl Kit
- Ratchet
- Upper Hook Assembly
- Lower Hook Assembly
- Upper Latch Kit
- Lower Latch Kit
- Load Chain
- Hand Chain

WARNING

Alterations or modifications of equipment and use of any parts other than COFFING LHH manual hoist repair parts can lead to dangerous operation and injury.

TO AVOID INJURY:

Do not alter or modify equipment. Do use only COFFING LHH provided replacement parts.

PARTS DIAGRAM

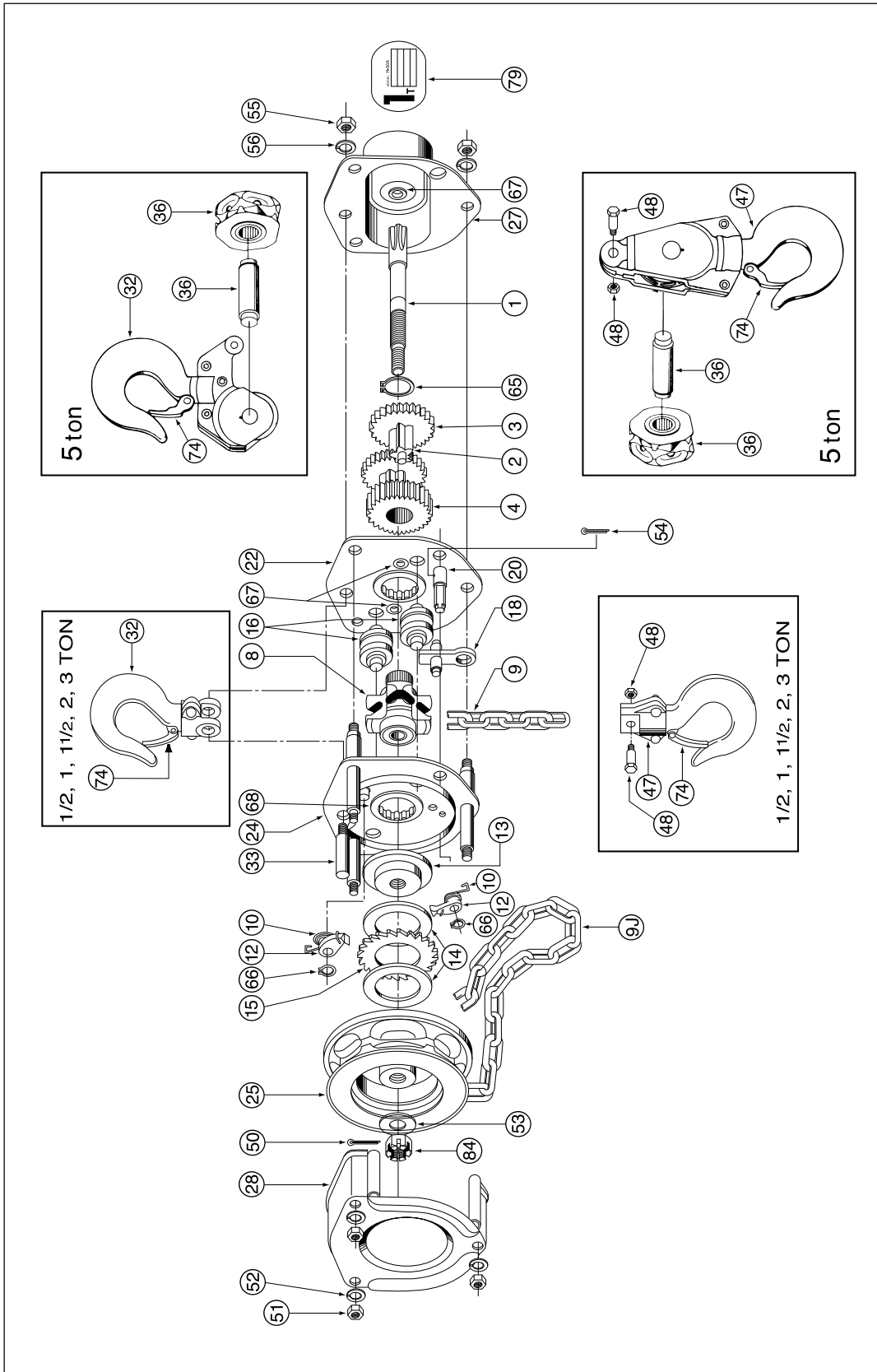

ENGLISH

REPAIR PARTS LIST (CONTINUED)

PARTS LIST FOR 1/2 TON, 1 TON, 1½ TON, 2 TON, 3 TON, AND 5 TON MODELS

Description	Consists of Index No.	1/2 Ton Part No.	1 Ton Part No.	1½ Ton Part No.	2 Ton Part No.	3 Ton Part No.	5 Ton Part No.
Pinion Shaft	1	GHH5001	JHH5001	KHH5001	LHH5001	NHH5001	KHH5001
Pinion Gear	2, 3 (Set of 2)	GHH5003T	JHH5003T	KHH5003T	LHH5003T	NHH5003T	KHH5003T
Load Gear	4	GHH5004	JHH5004	KHH5004	LHH5004	NHH5004	KHH5004
Load Sheave	8	GHE5008	JHE5008	KHE5008	LHE5008	NHH5008	KHH5008T
Hand Chain (Per Foot)	7	GHH5009J	GHH5009J	GHH5009J	GHH5009J	GHH5009J	GHH5009J
Load Chain (Per Foot)	9	GHH5009T	JHH5009T	KHH5009T	LHH5009T	NHH5009T	KHH5009T
Pawl Kit	10, 12, 66	GHH5099	JHH5099	KHH5099	LHH5099	NHH5099	KHH5099
Disc Hub	13	GHH5013	JHH5013	KHH5013	LHH5013	LHH5013	KHH5013
Friction Disc	14 (Set of 2)	GHH5014	JHH5014	KHH5014	LHH5014	LHH5014	KHH5014
Ratchet	15	GHH5015	JHH5015	KHH5015	LHH5015	LHH5015	KHH5015
Handwheel Cover	28	GHH5028	JHH5028	KHH5028	LHH5028	NHH5028	KHH5028
Top Hook	32 w/ 74	GHH5032T	JHH5032T	KHH5032T	LHH5032T	NHH5032T	PHH5032T
Bottom Hook	47, 48 w/ 74	GHH5047U	JHH5047U	KHH5047U	LHH5047U	NHH5047U	PHH5047U
Chain Fastening Bolt	48	GHH5048U	JHH5048U	KHH5048U	LHH5048U	NHH5048U	PHH5048U
Hardware Repair Kit Per Hoist	50, 51, 52 53, 54, 55 56, 65, 84	GHH5586	JHH5586	KHH5586	LHH5586	NHH5586	KHH5586
Bearing for Pinion	67 (Set of 4)	GHH5067	GHH5067	KHH5067	LHH5067	TR132713NR	KHH5067
Bearing for Load Sheave	68 (Set of 2)	GHE5005	JHE5005	KHE5005	LHE5005	TR506213NR	TR364710NR
Latch Kit	74	GHH5074U	JHH5074U	KHH5074U	KHH5074U	NHH5074U	PHH5074U
Chain Guide Kit	16 (2), 18, 20	GHH161820	JHH161820	KHH161820	LHH161820	NHH161820	KHH161820
Gear Side Plate	22 w/o 67, 68	GHH5022	JHH5022	KHH5022	LHH5022	NHH5022	KHH5022
Wheel Side Plate	24 w/o 68	GHE5024T	JHE5024T	KHE5024T	LHE5024T	NHE5024T	KHH5024T
Handwheel	25	GHH5025	JHH5025	KHH5025	LHH5025	NHH5025	KHH5025
Gear Cover	27 w/o 67, 79	GHH5027	JHH5027	KHH5027	LHH5027	NHH5027	KHH5027
Yoke Pin	33	RH4010033	RH4010033	RH4015033	RH4020033	RH4030033	RH4015033
Decal	79	LHH674 6	LHH674 7	LHH674 16	LHH674 8	LHH674 9	LHH674 10
Idle Sheave Assembly	36	LHH674 5	-	LHH674 16	-	-	PHH5042

When ordering spare parts, be sure to state part number, capacity, model number and quantities, referring to the above list.

WARRANTY

LIMITATION OF WARRANTIES, REMEDIES AND DAMAGES

INDEMNIFICATION AND SAFE OPERATION

Buyer shall comply with and require its employees to comply with directions set forth in instructions and manuals furnished by Seller and shall use and require its employees to follow such instructions and manuals and to use reasonable care in the use and maintenance of the goods. Buyer shall not remove or permit anyone to remove any warning or instruction signs on the goods. In the event of personal injury or damage to property or business arising from the use of the goods, Buyer shall within 48 hours thereafter give Seller written notice of such injury or damage. Buyer shall cooperate with Seller in investigating any such injury or damage and in the defense of any claims arising therefrom.

If Buyer fails to comply with this section or if any injury or damage is caused, in whole or in part, by Buyer's failure to comply with applicable federal or state safety requirements, Buyer shall indemnify and hold Seller harmless against any claims, loss or expense for injury or damage arising from the use of the goods.

CMCO Warranty (HOISTS)

A. Columbus McKinnon Corporation ("Seller") warrants to the original end user ("Buyer") that, for a period of one (1) year from the date of Seller's delivery of the goods (collectively, the "Goods") to the carrier, the Goods will be free from defects in workmanship and materials.

B. IN THE EVENT OF ANY BREACH OF SUCH WARRANTY, SELLER'S SOLE OBLIGATION SHALL BE EXCLUSIVELY LIMITED TO, AT THE OPTION OF SELLER, REPAIR OR REPLACEMENT, F.O.B. SELLER'S POINT OF SHIPMENT, OF ANY GOODS THAT SELLER DETERMINES TO HAVE BEEN DEFECTIVE OR, IF SELLER DETERMINES THAT SUCH REPAIR OR REPLACEMENT IS NOT FEASIBLE, TO A REFUND OF THE PURCHASE PRICE UPON RETURN OF THE GOODS TO SELLER. NO CLAIM AGAINST SELLER FOR ANY BREACH OF (i) SUCH WARRANTY WITH RESPECT TO THE ELECTRICAL COMPONENTS OF ANY GOOD SHALL BE VALID OR ENFORCEABLE UNLESS BUYER'S WRITTEN NOTICE THEREOF IS RECEIVED BY SELLER WITHIN ONE (1) YEAR FROM THE DATE OF SELLER'S DELIVERY TO THE CARRIER AND (ii) SUCH WARRANTY WITH RESPECT TO THE MECHANICAL COMPONENTS OF ANY GOOD SHALL BE VALID OR ENFORCEABLE UNLESS BUYER'S WRITTEN NOTICE THEREOF IS RECEIVED BY SELLER WITHIN ONE (1) YEAR FROM THE DATE THE DATE ANY ALLEGED CLAIM ACCRUES. EXCEPT FOR THE WARRANTY SET FORTH ABOVE, SELLER MAKES NO OTHER WARRANTIES WITH RESPECT TO THE GOODS, WHETHER EXPRESSED OR IMPLIED, INCLUDING ANY WARRANTIES OF MERCHANTABILITY, FITNESS FOR A PARTICULAR PURPOSE, QUALITY AND/OR THOSE ARISING BY STATUTE OR OTHERWISE BY LAW OR FROM ANY

COURSE OF DEALING OR USE OF TRADE, ALL OF WHICH ARE HEREBY EXPRESSLY DISCLAIMED.

- C. IN NO EVENT SHALL SELLER BE LIABLE TO BUYER OR ANY THIRD PARTY WITH RESPECT TO ANY GOOD, WHETHER IN CONTRACT, TORT OR OTHER THEORY OF LAW, FOR LOSS OF PROFITS OR LOSS OF USE, OR FOR ANY INCIDENTAL, CONSEQUENTIAL, SPECIAL, DIRECT OR INDIRECT DAMAGES, HOWSOEVER CAUSED. SELLER'S MAXIMUM LIABILITY TO BUYER WITH RESPECT TO THE GOODS SHALL IN NO EVENT EXCEED THE PRICE PAID BY BUYER FOR THE GOODS THAT ARE THE SUBJECT OF THE APPLICABLE CLAIM.
- D. Seller shall not be liable for any damage, injury or loss arising out of the use of the Goods if, prior to such damage, injury or loss, such Goods are: (1) damaged or misused following Seller's delivery to the carrier; (2) not maintained, inspected, or used in compliance with applicable law and Seller's written instructions and recommendations; or (3) installed, repaired, altered or modified without compliance with such laws, instructions or recommendations.
- E. This warranty is limited and provided only to the original end user. **Each Good must be registered within sixty (60) days of receipt of each product to establish eligibility.** Please register at www.cmworks.com/hoist-warranty-registration or submit registration card via US mail.
- F. Any action against Seller for breach of warranty, negligence or otherwise in connection with the electrical components of any Good must be commenced by Buyer within one (1) year after: (a) the date any alleged claim accrues; or (b) the date of delivery of the Goods to Buyer, whichever is earlier. Any action against Seller for breach of warranty, negligence or otherwise in connection with the mechanical components of any Good must be commenced by Buyer within one (1) year after the date any alleged claim accrues.

WARNING

Alterations or modifications of equipment and use of nonfactory repair parts can lead to dangerous operation and injury.

TO AVOID INJURY:

- Do not alter or modify equipment.
- Do use only factory replacement parts.



FAMILY OF BRANDS



USA: Ph: (800) 888.0985 • (716) 689.5400 • Fax: (716) 689.5644 • www.cmworks.com

CANADA: Ph: (877) 264.6478 • Fax: (877) 264.6477 • www.cmworks.com